

WKC4.4T-5/TEL

Actuator and Sensor Cable, PVC – Connection Cable

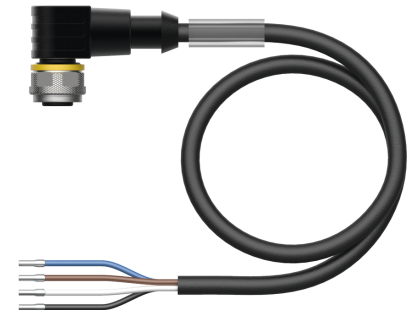
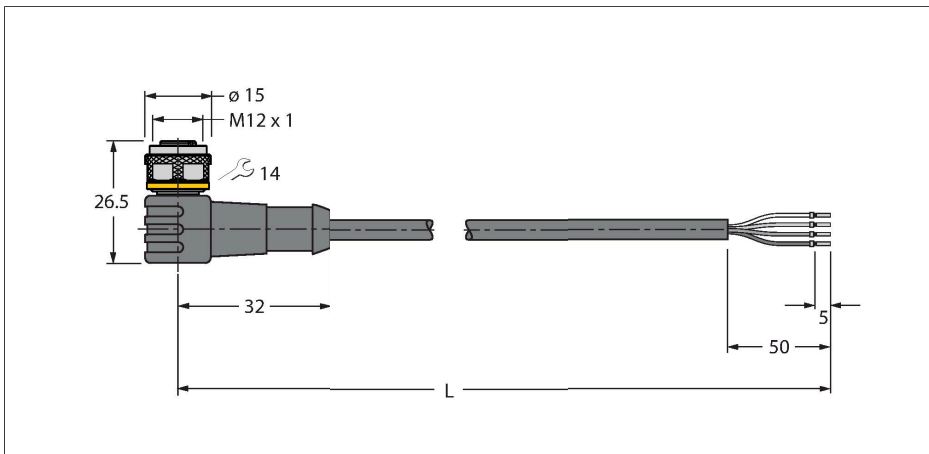

Technical data

| | |
|---------------------------------|--|
| Type | WKC4.4T-5/TEL |
| ID | 6625026 |
| Connector A | Female, M12 × 1, Angled, A-coded |
| Number of Pins | 4 |
| Contacts | Brass, CuZn, Gold-plated |
| Contact carriers | Plastic, TPU, Black |
| Connector body | Plastic, TPU, Black |
| Coupling nut/screw | Brass, CuZn, Nickel-plated |
| Seal | Plastic, FPM/FKM |
| Mechanical lifespan | > 100 Mating cycles |
| Pollution degree | 3 |
| Protection class | IP67, IP69K, Only in screwed condition |
| Cable | |
| Cable diameter | Ø 4.6 mm ±0.20 |
| Cable length | 5 m |
| Cable jacket | PVC, Black |
| Core insulation | PVC |
| Core cross-section | 4 x 0.34 mm ² |
| Arrangement of strands | 42 x 0.1 mm |
| Core colors | BN, WH, BU, BK |
| Electrical properties at +20 °C | |
| Rated voltage | 250 V |
| Test voltage | 2000 V |
| Current | 4 A |
| Insulation resistance | > 30.5 MΩ/km |
| forward resistance | max. 57 Ω/km |

Features



- Female M12, angled, 4-pin
- Jacket material: PVC
- Jacket color: black
- Resistant to chemicals and oils
- Flame retardant
- Resistant to acids and alkaline solutions
- Resistant to microbes and hydrolysis
- LABS free
- Protection class: IP67, IP69K
- Cable length: 5.0 m

Cable Cross-Section

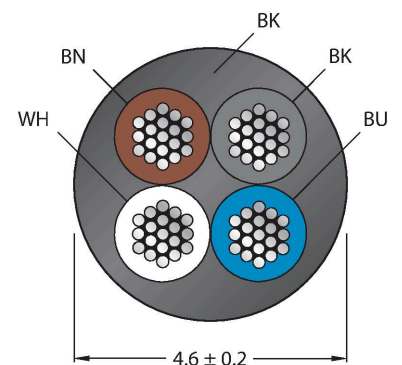

Contact assignment

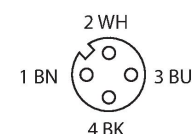

Technical data

Mechanical and chemical properties

| | |
|--|------------------------------|
| Bending radius (stationary installation) | $\geq 5 \times \varnothing$ |
| Bending radius (flexible use) | $\geq 10 \times \varnothing$ |
| Ambient temperature range (stationary) | -40...+105 °C |
| Ambient temperature range (In motion) | -5...+80 °C |
| Approvals | cULus |

Circuit Diagram

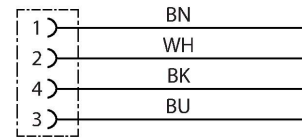

Accessories

HAS8141-0

6905406

Field-wireable male connector, M12 × 1, straight, 4-pin, insulation piercing connection, cable feedthrough 4.0 to 5.1 mm, core cross-section/terminal capacity 0.14 to 0.34 mm², plastic housing, metal nut

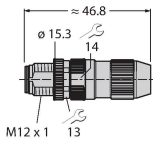

HAS8241-0

6905400

Field-wireable male connector, M12 × 1, angled, 4-pin, insulation piercing connection, cable feedthrough 4.0 to 5.1 mm, core cross-section/terminal capacity 0.14 to 0.34 mm², plastic housing, metal nut

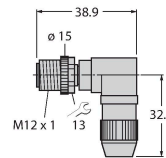

BS8141-0

69010

Field-wireable male connector, M12 × 1, straight, 4-pin, screw terminal connection, cable feedthrough 4.0 to 6.0 mm, core cross-section/terminal capacity 0.14 to 0.75 mm², plastic housing, metal retaining screw

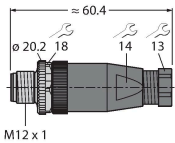

BS8241-0

69011

Field-wireable connector, M12 × 1, angled, 4-pin, screw terminal connection, cable feedthrough 4.0 to 6.0 mm, core cross-section/terminal capacity 0.14 to 0.75 mm², plastic housing, metal retaining screw

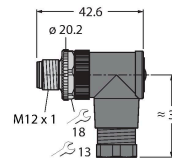

FW-ERSPM0426-SA-P-0408

100002048

Field-wireable male connector, M12 × 1, straight, 4-pin, push-in connection, cable feedthrough 4.0 to 8.0 mm, core cross-section/terminal capacity 0.14 to 0.75 mm², plastic housing, metal retaining screw

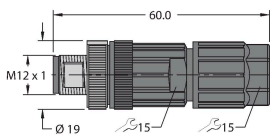

FW-ERSPM0416-SA-S-0408

100002288

Field-wireable male connector, M12 × 1, straight, 4-pin, screw terminal connection, cable feedthrough 4.0 to 8.0 mm, core cross-section/terminal capacity 0.25 to 1.5 mm², plastic housing, metal retaining screw

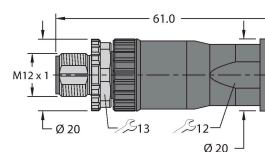

FW-EWSPM0416-SA-S-0408

100002290

Field-wireable male connector, M12 × 1, angled, 4-pin, screw terminal connection, cable feedthrough 4.0 to 8.0 mm, core cross-section/terminal capacity 0.25 to 1.5 mm², plastic housing, metal retaining screw

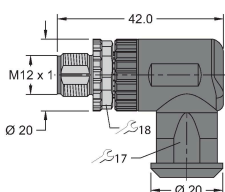

TORQUE-WRENCH-SET-AS

6936170

Torque wrench set; handles with adjustable torque 0.4-1.0 Nm, torque wrench for M8 (SW9), fork wrench for M12 (SW 14)

BLANK-LABEL-FOR-CORDSETS-TEL-TXL 6936206

Label for TEL and TXL cables, length: 18 mm, height: 4 mm, material: polycarbonate (PC), color: white, halogen-free and flame-retardant

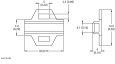

Accessories

| Dimension drawing | Type | ID | |
|---|-----------------------|-----------|--|
|  | LABEL-HOLDER-FLEX-PVC | 100048170 | PVC label holder for identification of extension cables (TEL/TXL product series); for cable diameters: min. 5 mm; dimensions 4 × 18 mm; delivery unit: 50 pcs. per package |