

Accesorii

Suport de montare

MW-12

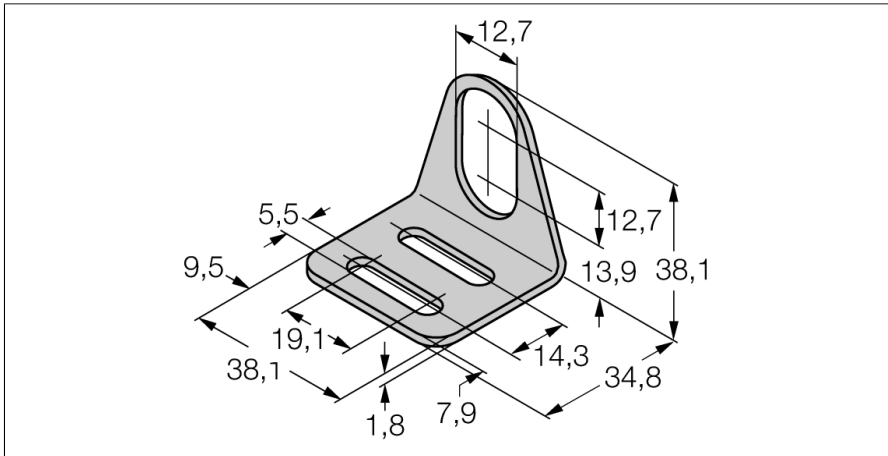

- Suport de montare pentru senzori cilindrici filetați M12 x1
- oțel inoxidabil A2 1.4301 (AISI 304)

Descriere generală

The mounting bracket for the sensor in the threaded barrel M12 x1 provides high flexibility for mounting. The position of the sensor can easily be re-adjusted in all directions and is thus very user friendly.

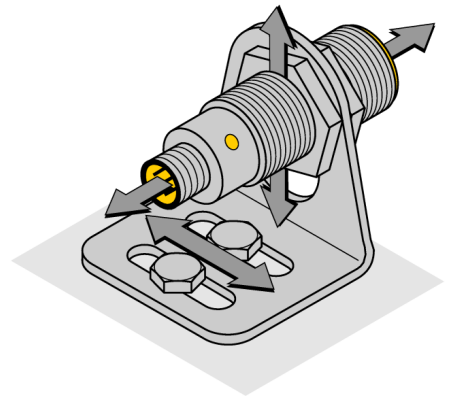

Tip	MW-12
Nr. ID	6945003
Design	Accesorii pentru cilindri filetați, M12
Dimensiuni	34.8 x 38.1 x 38.1mm
Materialul carcasei	Metal, 1.4301 (AISI 304)